

规格书 | 型号: 2106-1301

3线普通接线端子; 具有操作手柄及直插型笼式弹簧接线单元; 6 mm²; 有测试插孔; 侧面/中心标记; 适于35 x 15 和 35 x 7.5导轨; Push-in CAGE CLAMP®; 6,00 mm²; 灰色

www.wago.com/2106-1301

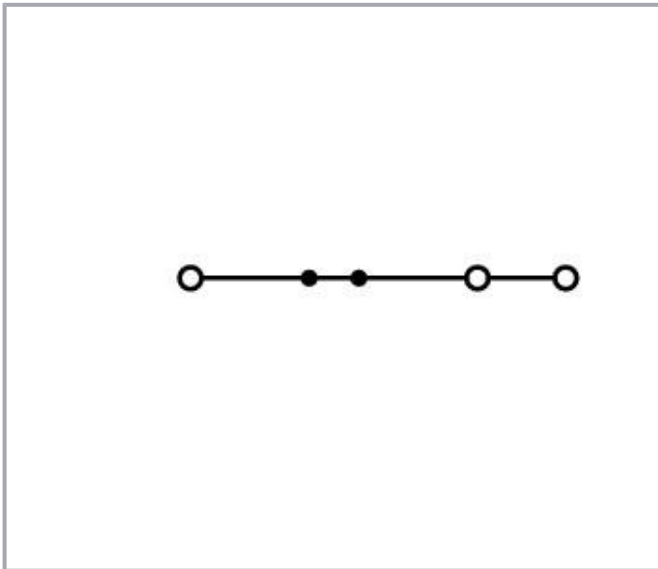
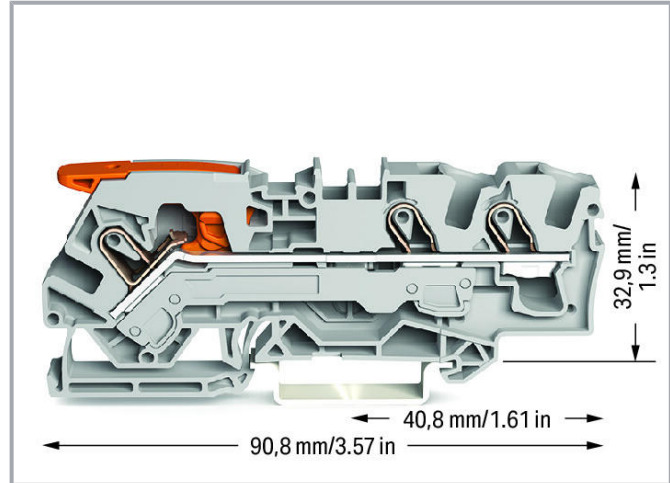
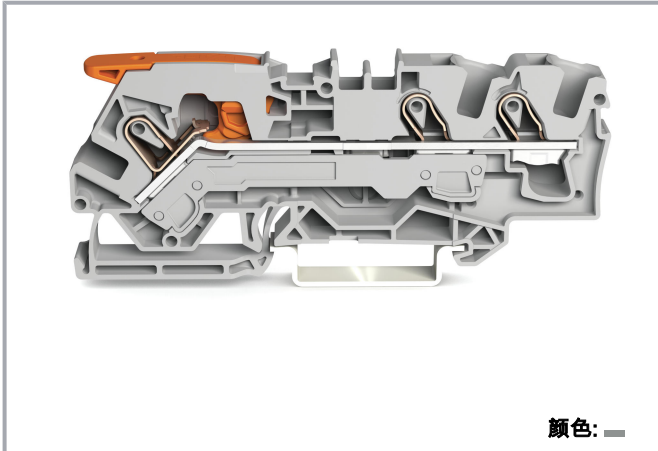

数据

电气参数

Ratings per IEC/EN

额定电气参数依据的标准	IEC/EN 60947-7-1
额定电压(III/3)	800 V

变更声明。 敬请关注进一步的产品说明文件！

WAGO Electronic (Tianjin) Co., Ltd.
No.5, Quan Hui Road
Wuqing Development Area | Tianjin 301700
Tel.: +86 22 59677688 | Fax: +86 22 59617668
Email: info-cn@wago.com

您有关于我们产品的任何问题吗？
我们非常乐意接听您的来电， +86 (022) 59677688。

额定浪涌电压(III/3)	8 kV
额定电流	41 A
额定电流2	55 A
图例(额定电气参数)	(III / 3) Δ 过电压类别III/污染等级3

Approvals per UL

认证	UL 1059
额定电压 UL(Use Group B)	600 V
额定电流 UL(Use Group B)	50 A
额定电压 UL(Use Group C)	600 V
额定电流 UL(Use Group C)	50 A
额定电压 UL(Use Group D)	600 V
额定电流 UL(Use Group D)	5 A

Approvals per CSA

认证	C22.2 No 158
额定电压 CSA (Use Group B)	600 V
额定电流 CSA (Use Group B)	45 A
额定电压 CSA (Use Group C)	600 V
额定电流 CSA (Use Group C)	45 A

Ex information

Ratings per	ATEX: PTB 18 ATEX 1011 U / IECEx: PTB 18.0018U (Ex eb IIC Gb)
额定电压EN (Ex e II)	550 V
额定电流(Ex e II)	41 A
带跨接器时的额定电流((Ex e II)	33 A

接线参数

连接技术	直插型笼式弹簧接线单元(Push-in CAGE CLAMP®)
执行类型	推入式 操作手柄
执行类型2	推入式 操作工具
可连接导线材料	铜
额定导线截面积	6 mm ²
单股导线	0.5 ... 10 mm ² / 20 ... 8 AWG
单股导线 ; 可直接插入	1 ... 10 mm ² / 14 ... 8 AWG

变更声明。 敬请关注进一步的产品说明文件！

WAGO Electronic (Tianjin) Co., Ltd.
No.5, Quan Hui Road
Wuqing Development Area | Tianjin 301700
Tel.: +86 22 59677688 | Fax: +86 22 59617668
Email: info-cn@wago.com

您有关于我们产品的任何问题吗？
我们非常乐意接听您的来电， +86 (022) 59677688。

细多股导线	0.5 ... 10 mm ² / 20 ... 8 AWG
细多股导线 ; 加有带绝缘护套的冷压接头	0.5 ... 6 mm ² / 20 ... 10 AWG
细多股导线 ; 加有冷压接头 ; 可直接插入	2.5 ... 6 mm ² / 16 ... 10 AWG
说明(导线截面积)	横截面较小的导线也可以直接插入,具体取决于导线特性。
剥线长度	13 ... 15 mm / 0.51 ... 0.59 英寸
连接点总数	3
电位总数量	1
层数	1
接线类型	正面接线
跨接器插孔数量	2

Geometrical Data

宽度	7.5 mm / 0.295 inch
高度	90.8 mm / 3.575 inch
以DIN导轨的上边线为基准的深度	32.9 mm / 1.295 inch

机械参数

设计	水平型
安装方式	DIN-35型导轨
标记位	中央/侧面标记位

材料参数

颜色	灰色
绝缘材料	尼龙66 (PA 66)
重量	17 g

商业数据

包装类型	BOX
原产国	DE
GTIN	4055143742054
海关税号	85369010000

认证 / 证书

Ex防爆认证

标识	认证	其他认证信息	认证名称
	AEx	UL 60079	E185892

变更声明。 敬请关注进一步的产品说明文件！

WAGO Electronic (Tianjin) Co., Ltd.
No.5, Quan Hui Road
Wuqing Development Area | Tianjin 301700
Tel.: +86 22 59677688 | Fax: +86 22 59617668
Email: info-cn@wago.com

您有关于我们产品的任何问题吗？
我们非常乐意接听您的来电， +86 (022) 59677688。



UL International Germany GmbH c/o Physikalisch
Technische Bundesanstalt



ATEX
Physikalisch Technische Bundesanstalt

EN 60079-0

PTB 18 ATEX
1011 U



CCCEX
CQST/CNEx

CNCA-C23-01

2020312313000164



EAC
Brjansker Zertifizierungsstelle

TP TC 012/2011

RU C-DE.AM02.B.
00127/19



IECEX
Physikalisch Technische Bundesanstalt

IEC 60079-0

IECEX PTB
18.0018U

船级社认证

标识	认证	其他认证信息	认证名称
	CCA DEKRA Certification B.V.	EN 60947	NTR NL 7678
	CSA DEKRA Certification B.V.	C22.2	70175103
	KEMA/KEUR DEKRA Certification B.V.	EN 60947	71- 103226

船级社认证

标识	认证	其他认证信息	认证名称
	ABS American Bureau of Shipping	-	19- HG1866350- PDA
	DNV GL Det Norske Veritas, Germanischer Lloyd	-	TAE00003JT

变更声明。敬请关注进一步的产品说明文件！

WAGO Electronic (Tianjin) Co., Ltd.
No.5, Quan Hui Road
Wuqing Development Area | Tianjin 301700
Tel.: +86 22 59677688 | Fax: +86 22 59617668
Email: info-cn@wago.com

您关于我们产品的任何问题吗？
我们非常乐意接听您的来电，+86 (022) 59677688。



LR
Lloyds Register

19/20050

UL-Approvals

标识	认证	其他认证信息	认证名称
	UL Underwriters Laboratories Inc.	UL 1059	20181005- E45172





所需附件

End plate

	型号: 2106-1391 端板和隔板; 厚度 1 mm; 适用于3线接线端子; 灰色	www.wago.com/2106-1391
	型号: 2106-1392 端板和隔板; 厚度 1 mm; 适用于3线接线端子; 橙色	www.wago.com/2106-1392

适用产品

check

	型号: 2006-511 模块化TOPJOB®S连接器; 模块化; 适用于跨接器接点槽; 1极; 6,00 mm ² ; 灰色	www.wago.com/2006-511
	型号: 2006-549 间隔模块; 模块化; 例如, 用于间隔已跨接的接线端子; 灰色	www.wago.com/2006-549
	型号: 2009-174 测试插头适配器; 适于测试插头4 mm Ø; 用于测试 TOPJOB® S 轨道式端子板; 灰色	www.wago.com/2009-174
	型号: 2009-182 测试插头; 适用最大 2.5 mm ² ; 可不使用任何工具与单根测试导线 (0.08 - 2.5 mm ²) 连接; 灰色	www.wago.com/2009-182
	型号: 210-136 测试插头; 2 mm Ø; 带500 mm长电缆; 红色	www.wago.com/210-136

protection

	型号: 2006-191 封闭帽; 用于导线进线孔和操作孔; 灰色	www.wago.com/2006-191
--	---	--

变更声明。敬请关注进一步的产品说明文件！

WAGO Electronic (Tianjin) Co., Ltd.
No.5, Quan Hui Road
Wuqing Development Area | Tianjin 301700
Tel.: +86 22 59677688 | Fax: +86 22 59617668
Email: info-cn@wago.com

您有关于我们产品的任何问题吗？
我们非常乐意接听您的来电， +86 (022) 59677688。

Marking accessories

型号: 2009-110 标记条; 适于Smart Printer; 卷装; not stretchable; 空白; 卡装式; 白色	www.wago.com/2009-110
型号: 2009-115 WMB-Inline; 适于Smart Printer; 每卷1500个标记; 5 - 5.2 mm可伸缩; 空白; 卡装式; 白色	www.wago.com/2009-115
型号: 2009-115/000-002 WMB-Inline; 适于Smart Printer; 每卷1500个标记; 5 - 5.2 mm可伸缩; 空白; 卡装式; 黄色	www.wago.com/2009-115/000-002
型号: 2009-115/000-006 WMB-Inline; 适于Smart Printer; 每卷1500个标记; 5 - 5.2 mm可伸缩; 空白; 卡装式; 蓝色	www.wago.com/2009-115/000-006
型号: 2009-115/000-007 WMB-Inline; 适于Smart Printer; 每卷1500个标记; 5 - 5.2 mm可伸缩; 空白; 卡装式; 灰色	www.wago.com/2009-115/000-007
型号: 2009-115/000-012 WMB-Inline; 适于Smart Printer; 每卷1500个标记; 5 - 5.2 mm可伸缩; 空白; 卡装式; 橙色	www.wago.com/2009-115/000-012
型号: 2009-115/000-017 WMB-Inline; 适于Smart Printer; 每卷1500个标记; 5 - 5.2 mm可伸缩; 空白; 卡装式; 浅绿色	www.wago.com/2009-115/000-017
型号: 2009-115/000-023 WMB-Inline; 适于Smart Printer; 每卷1500个标记; 5 - 5.2 mm可伸缩; 空白; 卡装式; 绿色	www.wago.com/2009-115/000-023
型号: 2009-115/000-024 WMB-Inline; 适于Smart Printer; 每卷1500个标记; 5 - 5.2 mm可伸缩; 空白; 卡装式; 紫色	www.wago.com/2009-115/000-024
型号: 2009-145 Mini-WSB Inline; 适于Smart Printer; 每卷1700个标记; 5 - 5.2 mm可伸缩; 空白; 卡装式; 白色	www.wago.com/2009-145
型号: 2009-145/000-002 Mini-WSB Inline; 适于Smart Printer; 每卷1700个标记; 5 - 5.2 mm可伸缩; 空白; 卡装式; 黄色	www.wago.com/2009-145/000-002
型号: 2009-145/000-005 Mini-WSB Inline; 适于Smart Printer; 每卷1700个标记; 5 - 5.2 mm可伸缩; 空白; 卡装式; 红色	www.wago.com/2009-145/000-005
型号: 2009-145/000-006 Mini-WSB Inline; 适于Smart Printer; 每卷1700个标记; 5 - 5.2 mm可伸缩; 空白; 卡装式; 蓝色	www.wago.com/2009-145/000-006
型号: 2009-145/000-007 Mini-WSB Inline; 适于Smart Printer; 每卷1700个标记; 5 - 5.2 mm可伸缩; 空白; 卡装式; 灰色	www.wago.com/2009-145/000-007

变更声明。敬请关注进一步的产品说明文件！

WAGO Electronic (Tianjin) Co., Ltd.
 No.5, Quan Hui Road
 Wuqing Development Area | Tianjin 301700
 Tel.: +86 22 59677688 | Fax: +86 22 59617668
 Email: info-cn@wago.com

您有关于我们产品的任何问题吗？
 我们非常乐意接听您的来电，+86 (022) 59677688。

	型号: 2009-145/000-012 Mini-WSB Inline; 适于Smart Printer; 每卷1700个标记; 5 - 5.2 mm可伸缩; 空白; 卡装式; 橙色	www.wago.com/2009-145/000-012
	型号: 2009-145/000-023 Mini-WSB Inline; 适于Smart Printer; 每卷1700个标记; 5 - 5.2 mm可伸缩; 空白; 卡装式; 绿色	www.wago.com/2009-145/000-023
	型号: 2009-145/000-024 Mini-WSB Inline; 适于Smart Printer; 每卷1700个标记; 5 - 5.2 mm可伸缩; 空白; 卡装式; 紫色	www.wago.com/2009-145/000-024
	型号: 2009-191 组标记支架	www.wago.com/2009-191
	型号: 2009-192 组标记支架	www.wago.com/2009-192
	型号: 2009-193 组标记支架	www.wago.com/2009-193
	型号: 2009-198 适配器; 灰色	www.wago.com/2009-198
	型号: 248-501 Mini-WSB标记牌; 详见卡片; not stretchable; 空白; 卡装式; 白色	www.wago.com/248-501
	型号: 248-501/000-002 Mini-WSB标记牌; 详见卡片; not stretchable; 空白; 卡装式; 黄色	www.wago.com/248-501/000-002
	型号: 248-501/000-005 Mini-WSB标记牌; 详见卡片; not stretchable; 空白; 卡装式; 红色	www.wago.com/248-501/000-005
	型号: 248-501/000-006 Mini-WSB标记牌; 详见卡片; not stretchable; 空白; 卡装式; 蓝色	www.wago.com/248-501/000-006
	型号: 248-501/000-007 Mini-WSB标记牌; 详见卡片; not stretchable; 空白; 卡装式; 灰色	www.wago.com/248-501/000-007
	型号: 248-501/000-012 Mini-WSB标记牌; 详见卡片; not stretchable; 空白; 卡装式; 橙色	www.wago.com/248-501/000-012
	型号: 248-501/000-017 Mini-WSB标记牌; 详见卡片; not stretchable; 空白; 卡装式; 浅绿色	www.wago.com/248-501/000-017
	型号: 248-501/000-023 Mini-WSB标记牌; 详见卡片; not stretchable; 空白; 卡装式; 绿色	www.wago.com/248-501/000-023

变更声明。敬请关注进一步的产品说明文件！

WAGO Electronic (Tianjin) Co., Ltd.
No.5, Quan Hui Road
Wuqing Development Area | Tianjin 301700
Tel.: +86 22 59677688 | Fax: +86 22 59617668
Email: info-cn@wago.com

您有关于我们产品的任何问题吗？
我们非常乐意接听您的来电， +86 (022) 59677688。

	型号: 248-501/000-024 Mini-WSB标记牌; 详见卡片; not stretchable; 空白; 卡装式; 紫色	www.wago.com/248-501/000-024
	型号: 793-501 WMB标记卡; 详见卡片; not stretchable; 空白; 卡装式; 白色	www.wago.com/793-501
	型号: 793-501/000-002 WMB标记卡; 详见卡片; not stretchable; 空白; 卡装式; 黄色	www.wago.com/793-501/000-002
	型号: 793-501/000-005 WMB标记卡; 详见卡片; not stretchable; 空白; 卡装式; 红色	www.wago.com/793-501/000-005
	型号: 793-501/000-006 WMB标记卡; 详见卡片; not stretchable; 空白; 卡装式; 蓝色	www.wago.com/793-501/000-006
	型号: 793-501/000-007 WMB标记卡; 详见卡片; not stretchable; 空白; 卡装式; 灰色	www.wago.com/793-501/000-007
	型号: 793-501/000-012 WMB标记卡; 详见卡片; not stretchable; 空白; 卡装式; 橙色	www.wago.com/793-501/000-012
	型号: 793-501/000-017 WMB标记卡; 详见卡片; not stretchable; 空白; 卡装式; 浅绿色	www.wago.com/793-501/000-017
	型号: 793-501/000-023 WMB标记卡; 详见卡片; not stretchable; 空白; 卡装式; 绿色	www.wago.com/793-501/000-023
	型号: 793-501/000-024 WMB标记卡; 详见卡片; not stretchable; 空白; 卡装式; 紫色	www.wago.com/793-501/000-024
	型号: 793-5501 WMB标记卡; 详见卡片; 用于接线端子厚度 5 - 17.5 mm; 5 - 5.2 mm可伸缩; 空白; 卡装式; 白色	www.wago.com/793-5501
	型号: 793-5501/000-002 WMB标记卡; 详见卡片; 用于接线端子厚度 5 - 17.5 mm; 5 - 5.2 mm可伸缩; 空白; 卡装式; 黄色	www.wago.com/793-5501/000-002
	型号: 793-5501/000-005 WMB标记卡; 详见卡片; 用于接线端子厚度 5 - 17.5 mm; 5 - 5.2 mm可伸缩; 空白; 卡装式; 红色	www.wago.com/793-5501/000-005
	型号: 793-5501/000-006 WMB标记卡; 详见卡片; 用于接线端子厚度 5 - 17.5 mm; 5 - 5.2 mm可伸缩; 空白; 卡装式; 蓝色	www.wago.com/793-5501/000-006

变更声明。敬请关注进一步的产品说明文件！

WAGO Electronic (Tianjin) Co., Ltd.
No.5, Quan Hui Road
Wuqing Development Area | Tianjin 301700
Tel.: +86 22 59677688 | Fax: +86 22 59617668
Email: info-cn@wago.com

您有关于我们产品的任何问题吗？
我们非常乐意接听您的来电，+86 (022) 59677688。

	型号: 793-5501/000-007 WMB标记卡; 详见卡片; 用于接线端子厚度 5 - 17.5 mm; 5 - 5.2 mm可伸缩; 空白; 卡装式; 灰色	www.wago.com/793-5501/000-007
	型号: 793-5501/000-012 WMB标记卡; 详见卡片; 用于接线端子厚度 5 - 17.5 mm; 5 - 5.2 mm可伸缩; 空白; 卡装式; 橙色	www.wago.com/793-5501/000-012
	型号: 793-5501/000-017 WMB标记卡; 详见卡片; 用于接线端子厚度 5 - 17.5 mm; 5 - 5.2 mm可伸缩; 空白; 卡装式; 绿色	www.wago.com/793-5501/000-017
	型号: 793-5501/000-023 WMB标记卡; 详见卡片; 用于接线端子厚度 5 - 17.5 mm; 5 - 5.2 mm可伸缩; 空白; 卡装式; 浅绿色	www.wago.com/793-5501/000-023
	型号: 793-5501/000-024 WMB标记卡; 详见卡片; 用于接线端子厚度 5 - 17.5 mm; 5 - 5.2 mm可伸缩; 空白; 卡装式; 紫色	www.wago.com/793-5501/000-024
Jumper		
	型号: 2006-402 跨接器; 2插脚; 绝缘; 浅灰色	www.wago.com/2006-402
	型号: 2006-403 跨接器; 3插脚; 绝缘; 浅灰色	www.wago.com/2006-403
	型号: 2006-404 跨接器; 4插脚; 绝缘; 浅灰色	www.wago.com/2006-404
	型号: 2006-405 跨接器; 5插脚; 绝缘; 浅灰色	www.wago.com/2006-405
	型号: 2006-405/011-000 起点跨接器; 3插脚; 绝缘; 浅灰色	www.wago.com/2006-405/011-000
	型号: 2006-433 跨接器; 从1到3; 绝缘; 浅灰色	www.wago.com/2006-433
	型号: 2006-434 跨接器; 从1到4; 绝缘; 浅灰色	www.wago.com/2006-434
	型号: 2006-435 跨接器; 从1到5; 绝缘; 浅灰色	www.wago.com/2006-435
ferrule		
	型号: 216-208 冷压接头; 套管, 适于6 mm ² / AWG 10; 绝缘; 电镀锡; 电解铜; 气密压接; 符合DIN 46288-4/09.09标准; 黄色	www.wago.com/216-208
	型号: 216-262 冷压接头; 标识套管, 适用截面积 0.75 mm ² / AWG 18; 绝缘; 电镀锡; 电解铜; 气密压接; 符合DIN 46288-4	www.wago.com/216-262

变更声明。敬请关注进一步的产品说明文件！

WAGO Electronic (Tianjin) Co., Ltd.
No.5, Quan Hui Road
Wuqing Development Area | Tianjin 301700
Tel.: +86 22 59677688 | Fax: +86 22 59617668
Email: info-cn@wago.com

您有关于我们产品的任何问题吗？
我们非常乐意接听您的来电，+86 (022) 59677688。

	/09.09标准; 灰色	
	型号: 216-263 冷压接头; 套管, 适于1 mm ² / AWG 18; 绝缘; 电镀锡; 电解铜; 气密压接; 符合DIN 46288-4/09.09标准; 红色	www.wago.com/216-263
	型号: 216-264 冷压接头; 套管, 适于1.5 mm ² / AWG 16; 绝缘; 电镀锡; 电解铜; 气密压接; 符合DIN 46288-4/09.09标准; 黑色	www.wago.com/216-264
	型号: 216-266 冷压接头; 套管, 适于2.5 mm ² / AWG 14; 绝缘; 电镀锡; 电解铜; 气密压接; 符合DIN 46288-4/09.09标准; 蓝色	www.wago.com/216-266
	型号: 216-267 冷压接头; 套管, 适于4 mm ² / AWG 12; 绝缘; 电镀锡; 电解铜; 气密压接; 符合DIN 46288-4/09.09标准; 灰色	www.wago.com/216-267

Carrier rail

	型号: 210-112 钢质导轨; 35 x 7.5 mm; 厚度 1 mm; 长度 2 m; 带孔; 符合 EN 60715标准; "孔宽25 mm; 银色	www.wago.com/210-112
	型号: 210-113 钢质导轨; 35 x 7.5 mm; 厚度 1 mm; 长度 2 m; 不带孔; 符合 EN 60715标准; 银色	www.wago.com/210-113
	型号: 210-114 钢质导轨; 35 x 15 mm; 厚度 1.5 mm; 长度 2 m; 不带孔; 类似于EN 60715; 银色	www.wago.com/210-114
	型号: 210-115 钢质导轨; 35 x 7.5 mm; 厚度 1 mm; 长度 2 m; 带孔; 符合 EN 60715标准; "孔宽18 mm; 银色	www.wago.com/210-115
	型号: 210-118 钢质导轨; 35 x 15 mm; 厚度 2.3 mm; 长度 2 m; 不带孔; 符合 EN 60715标准; 银色	www.wago.com/210-118
	型号: 210-196 铝质导轨; 35 x 8.2 mm; 厚度 1.6 mm; 长度 2 m; 不带孔; 类似于EN 60715; 银色	www.wago.com/210-196
	型号: 210-197 钢质导轨; 35 x 15 mm; 厚度 1.5 mm; 长度 2 m; 带孔; 类似于EN 60715; 银色	www.wago.com/210-197
	型号: 210-198 铜质导轨; 35 x 15 mm; 厚度 2.3 mm; 长度 2 m; 不带孔; 符合 EN 60715标准; 铜色	www.wago.com/210-198

tools

	型号: 210-721 操作工具; 刀口尺寸 : 5.5 x 0.8 mm; 带有绝缘手柄; 多种颜色	www.wago.com/210-721
---	---	--

Protective Warning Marker

	型号: 2006-115 保护兼警告标志; 有高压符号, 黑色; 适于5个接线端子; 黄色	www.wago.com/2006-115
---	---	--

变更声明。 敬请关注进一步的产品说明文件！

WAGO Electronic (Tianjin) Co., Ltd.
No.5, Quan Hui Road
Wuqing Development Area | Tianjin 301700
Tel.: +86 22 59677688 | Fax: +86 22 59617668
Email: info-cn@wago.com

您有关于我们产品的任何问题吗？
我们非常乐意接听您的来电， +86 (022) 59677688。

下载 文档

Bid Text

2106-1301 docx - Datei	2019年4月15日	docx 15.2 kB	下载
---------------------------	------------	-----------------	----

2106-1301 X81 - Datei	2019年4月15日	xml 4.1 kB	下载
--------------------------	------------	---------------	----

Additional Information

Technical explanations	2019年4月3日	pdf 2.2 MB	下载
------------------------	-----------	---------------	----

CAD/CAE-Data

CAD data

2D/3D Models 2106-1301		URL	下载
------------------------	--	-----	----

CAE data

EPLAN Data Portal 2106-1301		URL	下载
-----------------------------	--	-----	----

ZUKEN Portal 2106-1301		URL	下载
------------------------	--	-----	----

Environmental Product Compliance

Compliance Search

Environmental Product Compliance 2106-1301		URL	下载
--	--	-----	----

3线普通接线端子; 具有操作手柄及直插型笼式弹簧接线单元; 6 mm²; 有测试插孔; 侧面/中心标记; 适于35 x 15 和 35 x 7.5导轨; Push-in CAGE CLAMP®; 6,00 mm²; 灰色

Installation Notes

连接导线

变更声明。 敬请关注进一步的产品说明文件！

WAGO Electronic (Tianjin) Co., Ltd.
No.5, Quan Hui Road
Wuqing Development Area | Tianjin 301700
Tel.: +86 22 59677688 | Fax: +86 22 59617668
Email: info-cn@wago.com

您关于我们产品的任何问题吗？
我们非常乐意接听您的来电， +86 (022) 59677688。

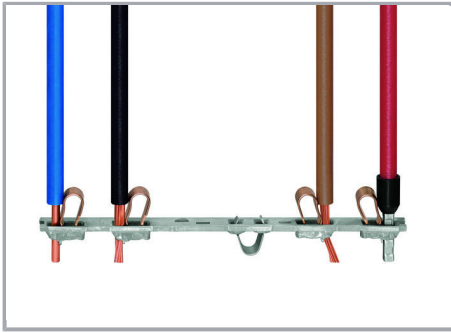

All conductor types at a glance

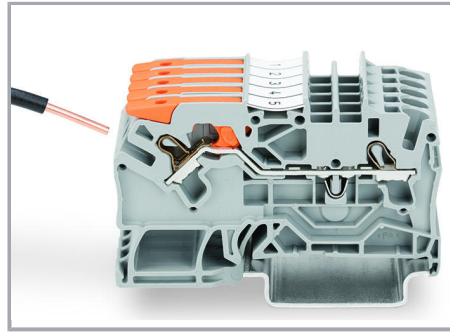

Push-in termination of solid conductors

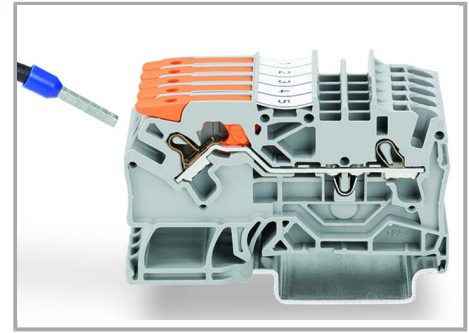

Push-in termination of fine-stranded conductors with ferrules

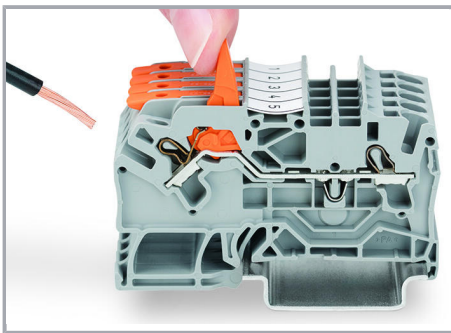

Pull the lever up until it stops, then connect the fine-stranded conductor.

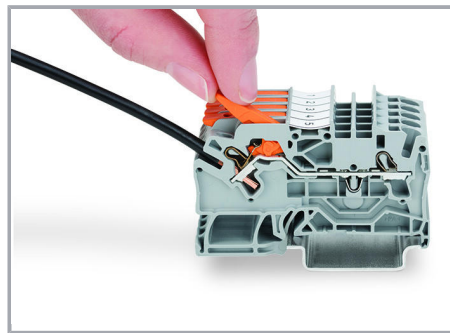

Push the lever back down – done!

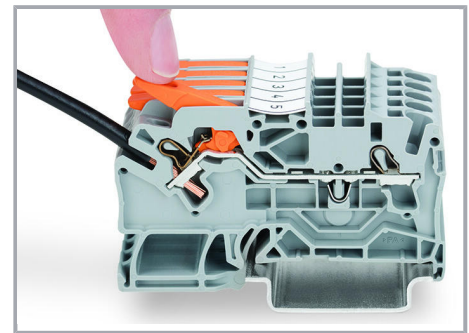

Push the lever back down – done!

跨接

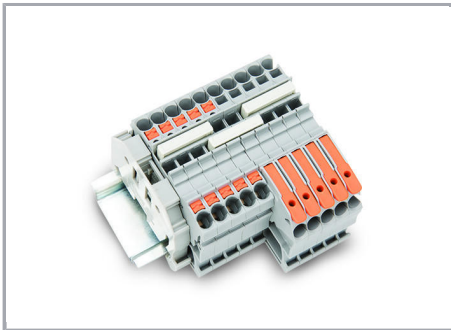

Insert a push-in type jumper bar and push down until it hits the backstop.

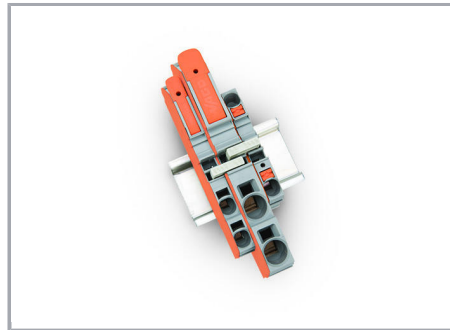

Commoning with step-down jumpers.

测试

变更声明。 敬请关注进一步的产品说明文件！

WAGO Electronic (Tianjin) Co., Ltd.
No.5, Quan Hui Road
Wuqing Development Area | Tianjin 301700
Tel.: +86 22 59677688 | Fax: +86 22 59617668
Email: info-cn@wago.com

您有关于我们产品的任何问题吗？
我们非常乐意接听您的来电， +86 (022) 59677688。

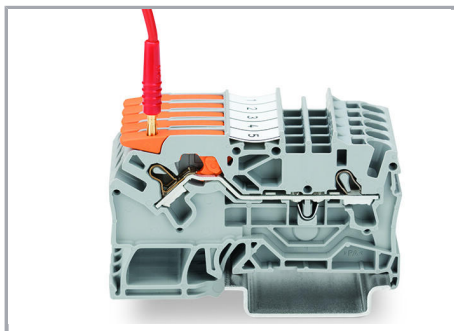

Testing with a 2 mm Ø test plug (max. 42 V).

标记

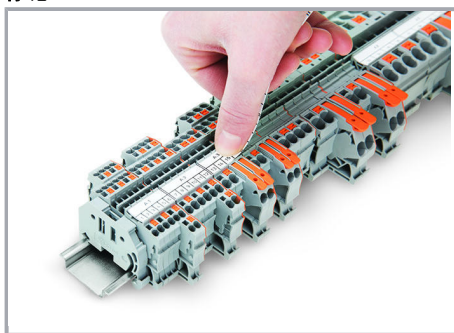

Snapping a marking strip into a marker slot.



Snapping a marking strip into the marker slot.

产品系列

TOPJOB® S

TOPJOB® S: In various industrial applications and modern building installations, WAGO's wide and versatile range of rail-mount terminal blocks provides more than just reliable electrical connections.

[显示该系列的所有产品。](#)

变更声明。 敬请关注进一步的产品说明文件！

WAGO Electronic (Tianjin) Co., Ltd.
No.5, Quan Hui Road
Wuqing Development Area | Tianjin 301700
Tel.: +86 22 59677688 | Fax: +86 22 59617668
Email: info-cn@wago.com

您有关于我们产品的任何问题吗？
我们非常乐意接听您的来电， +86 (022) 59677688。